



# Mod. KRATOS Mod. MAGNUM

ERPICI ROTANTI – HERSES ROTATIVES – POWER HARROWS  
KREISELEGGEN – GRADAS ROTATIVAS – РОТОРНЫЕ БОРОНЫ



**Erpici rotanti per la preparazione del terreno alla semina**

**Herses rotatives pour la preparation du lit de semence**

**Power harrows for ideal preparation of the soil ready for sowing**

**Kreiseleggen für eine ideale Saatbettvorbereitung**







**Gradas rotativas para la preparación del terreno de siembra**



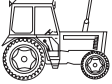

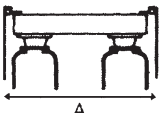

**Вращающиеся бороны для подготовки почвы к посеву**

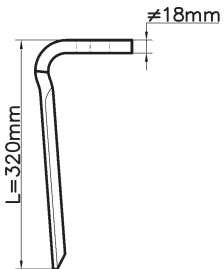

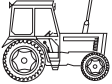
# Mod. KRATOS - MAGNUM

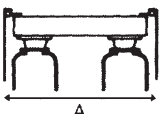
# FALC

KRATOS						 Ø 550		
	HP	PTO	A mm.	A Inches	KG	LBS	N.	
3000	90-200	1000	3115	122,64	1700	3747	12	
3500	120-200	1000	3607	142,01	1980	4365	14	
4000	130-200	1000	4099	161,38	2200	4850	16	

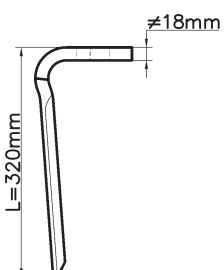
MAGNUM						 Ø 550		
	HP	PTO	A mm.	A Inches	KG	LBS	N.	
3000	100-240	1000	3115	122,64	1730	3814	12	
3500	120-240	1000	3607	142,01	2020	4453	14	
4000	130-240	1000	4099	161,38	2310	5093	16	
4500	150-240	1000	4591	180,75	2600	5732	18	
5000	160-240	1000	5083	200,12	2890	6371	20	

- 1. KRATOS per trattori da 90 a 200 HP. MAGNUM per trattori da 100 a 240 HP.
- 2. Cuscinetti a rulli conici di grandi dimensioni.
- 3. Supporti rotori imbullonati che conferiscono grande rigidità al telaio.
- 4. Supporti coltelli rotondi che riducono la possibilità di incastrò delle pietre e che permettono il montaggio della protezione sassi.
- 5. Coltelli di eccezionale robustezza con alta resistenza agli urti e all'usura (spessore 18 mm; lunghezza mm. 320).
- 6. Cambio rapido dei coltelli: i coltelli vengono inseriti nei supporti porta coltelli e fissati unicamente con perno e clip.

- 1. KRATOS pour tracteurs de 90-200 CV. MAGNUM pour tracteurs de 100-240 CV.
- 2. Roulements à rouleaux coniques de grande dimension.
- 3. Portes rotors boulonné qui donnent forte rigidité au châssis.
- 4. Porte-couteaux circulaires; ils réduisent la possibilité d'encastrement des pierres et permettent le montage de la "protection pierres".
- 5. Couteaux fortement robustes et très résistant aux heurtes et à l'usure (épaisseur 18 mm, longueur mm 320).
- 6. Attelage rapide des couteaux: les couteaux sont insérés dans les supports de couteaux et sont fixés uniquement par un axe et une goupille.

- 1. KRATOS for 90-200 HP tractors. MAGNUM for 100-240 HP tractors.
- 2. Tapered roller bearings of big dimensions.
- 3. Bolted rotors carriers that give a great hardness to the frame.
- 4. Circular blade carriers that reduce the possibility of stones joint; they also allow the fitting of stone protection guards.
- 5. Very strong blades with high resistance to the knocks and to the wear and tear (thickness 18 mm; (inches 0,71) length 320 mm (inches 12,60)).
- 6. Quick release for blades: each blade is simply positioned in the blade holder and fixed using a single pin.

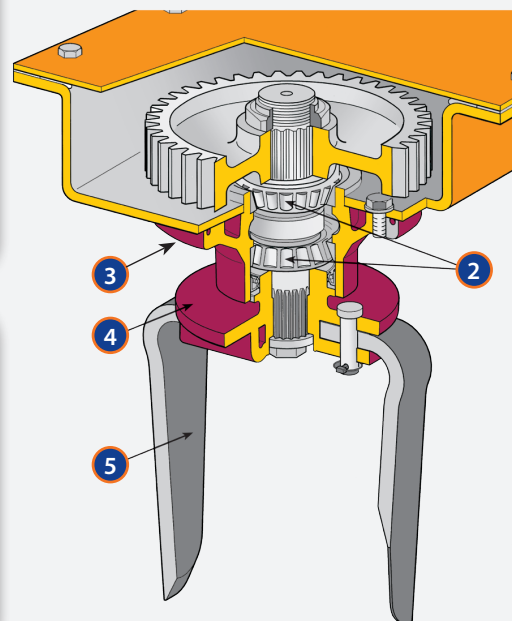



1. KRATOS für Traktoren von 90-200 PS. MAGNUM für Traktoren von 100-240 PS.
2. Große Kegelrollenlager.
3. Verschraubt Rotorhalter die der Chassis hohe Stabilität verleihen.
4. Runde Messerhalter, die das Einklemmen von Steinen vermindern und die Möglichkeit zum Anbau eines Steinschutzes bieten.
5. Außergewöhnlich robuste Messer mit hoher Stoß- und Verschleißfestigkeit (18 mm starken und 320 mm langen Messer).
6. Zinken-schnellwechsel: die Zinken werden in die Zinkenträger eingesetzt und nur mit einem Bolzen und Splint fixiert.



1. KRATOS para tractores de 90-200 HP. MAGNUM para tractores de 100-240 HP.
2. Cojinetes a rodamientos conicos de grandes dimensiones.
3. Soportes de los rotores atornillados que confieren gran rigidez al chasis.
4. Soportes redondos para cuchillas, que reducen la posibilidad de encaje de pedregullo y que permiten el montaje de la proteccion contra piedras.
5. Cuchillas de excepcional robustez con alta resistencia a los golpes y al desgaste (espesor 18 mm, largo 320 mm).
6. Cambio rápido de las cuchillas: las cuchillas se introducen en el soporte porta-cuchillas y son fijadas mediante un perno y un pasador.









1. KRATOS для тракторов от 90 до 200 л.с. MAGNUM для тракторов от 100 до 240 л.с.
2. Конические роликовые подшипники больших размеров
3. Опорные роторы, которые придают большую жесткость шасси
4. Опорные круглые ножи, которые уменьшают возможность блокировки камнями и которые позволяют монтаж защиты от камней
5. Ножи толщиной 18 мм, длиной 320 мм, высокой прочности и устойчивости к износу и ударам на каменистых почвах
6. Быстрая замена ножей: ножи вставляются в ножевые суппорты и закрепляются только болтом и зажимом.

<b>KRATOS</b> <b>Mod. MV 824</b>	IN DOTAZIONE EN DOTATION ON ISSUE	* VELOCITÀ INSERITA * VITESSE BRANCHEE * PLUGGED SPEED	A RICHIESTA SUR DEMANDE ON REQUEST	
		<b>MV 824</b> 1000		<b>MV 824</b> 1000
● 26		● 24	● 27	
○ 35		○ 37	○ 34	
359*		313	383	







<b>MAGNUM</b> <b>Mod. MV 826</b>	IN DOTAZIONE EN DOTATION ON ISSUE	* VELOCITÀ INSERITA * VITESSE BRANCHEE * PLUGGED SPEED	A RICHIESTA SUR DEMANDE ON REQUEST	
		<b>MV 826</b> 1000		<b>MV 826</b> 1000
● 30		● 23	● 27	● 33
○ 39		○ 46	○ 43	○ 36
365*		238	298	435

 **OPZIONI**  **OPTIONS**  **OPTIONS**  
 **OPTIONEN**  **OPCIONES**  **ВАРИАНТЫ**







-  **PROTEZIONE SASSI TRIANGOLARE**
-  **PROTECTION PIERRES TRIANGULAIRE**
-  **TRIANGLE STONE PROTECTION**
-  **DREIECKIG STEINSCHUTZ**
-  **PROTECCION PIEDRAS TRIANGULAR**
-  **ЗАЩИТА ОТ КАМНЕЙ**









-  **FIANCATE LATERALI SUPPLEMENTARI**
-  **FLANCS LATERAUX SUPPLEMENTAIRES**
-  **SUPPLEMENTARY LATERAL SIDES**
-  **EXTRA SEITLICHE FLANSCHEN**
-  **FLANCOS LATERALES SUPLEMENTARIOS**
-  **ДОПОЛНИТЕЛЬНЫЕ БОКОВИНЫ**







**ROMPITRACCIA - EFFACE-TRACE - TRACE BREAKER - SPURLOCKER - BORRAHUELLAS - СЛЕДОРЫХЛИТЕЛЕЙ**



-  **COPPIA DI ROMPITRACCIA STANDARD**
-  **COUPLE D'EFFACE-TRACE STANDARD**
-  **PAIR OF STANDARD TRACE BREAKER**
-  **STANDARD-SPURLOCKERERPAAR**
-  **PAR DE BORRAHUELLAS ESTÁNDAR**
-  **ПАРА СЛЕДОРЫХЛИТЕЛЕЙ СТАНДАРТНЫХ**

- COPPIA DI ROMPITRACCIA CON BULLONE DI ROTTURA** 
- COUPLE D'EFFACE-TRACE AVEC BOULON DE RUPTURE** 
- PAIR OF TRACE BREAKER WITH SHEAR BOLT TORQUE LIMITER** 
- SPURLOCKERERPAAR MIT BRUCHBOLZEN** 
- PAR DE BORRAHUELLAS CON PERNO DE ROTURA** 
- ПАРА СЛЕДОРЫХЛИТЕЛЕЙ СО СРЕЗНЫМ БОЛТОМ** 



-  **COPPIA DI ROMPITRACCIA CON MOLLE**
-  **COUPLE D'EFFACE-TRACE AVEC RESSORTS**
-  **PAIR OF TRACE BREAKER WITH SPRINGS**
-  **SPURLOCKERERPAAR MIT FEDERN**
-  **PAR DE BORRAHUELLAS CON MUELLES**
-  **ПАРА СЛЕДОРЫХЛИТЕЛЕЙ С ПРУЖИНАМИ**



# OPZIONI



# OPTIONS



# OPTIONS

## RULLI - ROULEAUX - ROLLERS - WALZEN - RODILLOS - KATOK



**RULLO A GABBIA - 8 tubi**  
**ROULEAU A CAGE - 8 tubes**  
**CAGE ROLLER - 8 tubes**  
**STABWALZE - 8 Rohre**  
**RODILLO TUBULAR - 8 tubos**  
**ТРУБЧАТЫЙ КАТОК - 8 труб**



**RULLO PACKER Ø mm 460 o 550**  
**ROULEAU PACKER Ø mm 460 ou 550**  
**PACKER ROLLER Ø mm 460 or 550**  
**PACKERWALZE Ø mm 460 oder 550**  
**RODILLO PACKER Ø mm 460 o 550**  
**KATOK PACKER И Ø mm 460 или 550**



**RULLO A SPUNTONI**  
**ROULEAU HERISSON**  
**SPIKED ROLLER**  
**SPORENWALZE**  
**RODILLO DE DIENTES**  
**ИГОЛЬЧАТЫЙ КАТОК**



**RULLO SPIROPACKER**  
**ROULEAU SPIROPACKER**  
**SPIROPACKER ROLLER**  
**SPIRALWALZE**  
**RODILLO SPIROPACKER**  
**KATOK SPIROPACKER**



**CARRELLO DI TRASPORTO**



**CHARIOT DE TRANSPORT**



**TRANSPORT TRUCK**



**FAHRGESTELL**



**CARRO DE TRANSPORTE**



**Транспортная тележка**



**Attacco seminatrice a sollevamento idraulico (1 pistone)**



**Attelage semoir à relevage hydraulique (1 vérin)**



**Hydraulic up and over linkage for sowing machine (1 jack)**



**Hydraulischer Huckepack für Sämaschinen (1 Winde)**



**Enganche sembradora a levantamiento hidráulico (1 pistón)**



**Крепление сеялки с гидравлическим подъёмом (1 поршень)**

**Attacco seminatrice a sollevamento idraulico (2 pistoni)**



**Attelage semoir à relevage hydraulique (2 vérins)**



**Hydraulic up and over linkage for sowing machine (2 jacks)**



**Hydraulischer Huckepack für Sämaschinen (2 Winde)**



**Enganche sembradora a levantamiento hidráulico (2 pistón)**



**Крепление сеялки с гидравлическим подъёмом (2 поршень)**



**FALC**



 **BARRA LIVELLATRICE IDRAULICA INTEGRATA AL RULLO (DISPONIBILE SOLO CON RULLO PACKER Ø 550 E RULLO GABBIA 8 TUBI)**

 **BARRE NIVELEUSE HYDRAULIQUE INTEGREE AU ROULEAU (DISPONIBLE UNIQUEMENT AVEC ROULEAU PACKER Ø 550 ET ROULEAU CAGE 8 TUBES)**

 **HYDRAULIC LEVELLING BAR CONNECTED TO THE ROLLER (AVAILABLE ONLY WITH PACKER ROLLER Ø 550 AND CAGE ROLLER 8 TUBES)**

 **IN DER WALZE INTEGRIERTE HYDRAULISCHE PLANIERSCHIENE (NUR MIT PACKERWALZE Ø 550 UND STABWALZE 8 ROHRE ERHÄLTlich)**

 **BARRA NIVELADORA HIDRÁULICA INTEGRADA EN EL RODILLO (DISPONIBLE SOLO CON RODILLO PACKER Ø 550 Y RODILLO TUBULAR 8 TUBOS)**

 **ВЫРАВНИВАЮЩАЯ ГИДРАВЛИЧЕСКАЯ ПЛАНКА В ДОПОЛНЕНИЕ К КАТКУ (ДОСТУПНО ТОЛЬКО С КАТКОМ PACKER Ø 550 И ТРУБЧАТЫМ КАТКОМ – 8 ТРУБ)**



 **BARRA LIVELLATRICE CON MANOVELLE INTEGRATA ALLA MACCHINA (DISPONIBILE PER TUTTI I TIPI DI RULLO)**

 **BARRE NIVELEUSE AVEC MANIVELLES INTEGREE A LA MACHINE (DISPONIBLE POUR TOUS LES TYPES DE ROULEAUX)**

 **LEVELLING BAR WITH CRANKS CONNECTED TO THE MACHINE (AVAILABLE FOR ALL KINDS OF ROLLERS)**

 **IM GERÄT INTEGRIERTE PLANIERSCHIENE MIT KURBELN (FÜR ALLE WALZENTYPEN)**

 **BARRA NIVELADORA CON MANIVELAS INTEGRADA EN LA MÁQUINA (PAR TODO TIPO DE RODILLOS)**

 **ВЫРАВНИВАЮЩАЯ ПЛАНКА С МАХОВИКАМИ В ДОПОЛНЕНИЕ К МАШИНЕ (ДОСТУПНА ДЛЯ ВСЕХ ВИДОВ КАТКОВ)**



**FALC**

Via Proventa, 41  
 48018 Faenza (Italia)  
 Tel. +39 0546 29050  
 Fax +39 0546 663986

www.falc.eu | info@falc.eu