

# CFU/500

Cimatrice bilama singola con tunnel - Single blade trimmer with tunnel  
 Rogneuse simple a section avec tunnel - Einseitiger laubschneider mit tunnel



Molla gas antiurto - Gas spring security  
 Securite avec vérin a gaz - Sicherheitsgasfeder



Bilama / Guide PVC - Double blade / PVC support  
 Double section / PVC lamier - Doppelklingen- / PVC-Führungen

Ø 1-2 cm





Molla sicurezza top  
 Top spring security  
 Ressort de securité top  
 Top Sicherheitsfeder



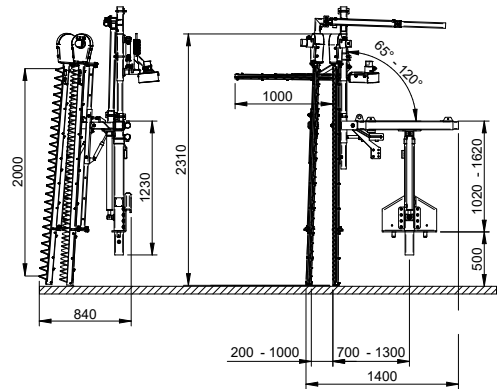
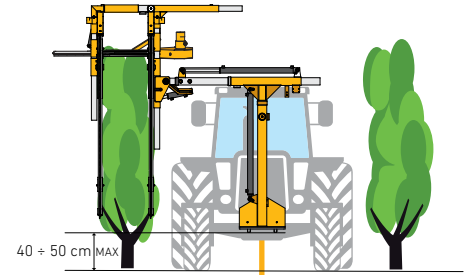





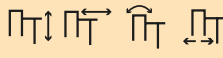

Aggancio rapido maschio | femmina  
 Quick connection male | female  
 Connection rapid male | female  
 Männliche | weibliche befestigung

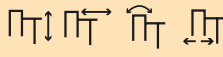

Dati tecnici | Technical data | Fiche technique | Technische Daten

MOD.	 cm	 Kg
CFU/500	60	260

COD.	Movimenti - Movements - Mouvements - Bewegungen	Levers	Joystick	Distributore	Oil - Pressure
103231L	4+1  + ON/OFF MOTOR				25 l/min 180 bar max
103231J	4+1  + ON/OFF MOTOR				25 l/min 180 bar max

**STAFFE PER TRATTORI E SERBATOI - TRACTOR BRACKETS AND OIL TANKS - SUPPORTS ET RÉSERVOIRS DE TRACTEUR - TRAKTORHALTERUNGEN UND TANKS** Pag. 55

OPTIONAL	Descrizione - Description - Description - Beschreibung	
1A32200	2 Convogliatori alzatralci idraulici - 2 Hydraulic conveyors 2 Convoyeur hydrauliques - 2 Hydraulische Hebebänder	
1A32237	Martinetto inclinazione topping 90° a leve o joystick (5+1) - 90° topping tilting jack with levers or joystick (5+1) Vérin d'inclination 90° avec leviers ou joystick (5+1) - 90° Kipphebel mit Hebeln oder Joystick (5+1)	

# STAFFE PER TRATTORI E SERBATOI OLIO

## TRACTOR BRACKETS AND OIL TANKS - SUPPORTS ET RÉSERVOIRS DE TRACTEUR - TRAKTORHALTERUNGEN UND TANKS

COD.	Descrizione - Description - Description - Beschreibung		Kg
1A32051	Staffa fissa maschio grezza per CIMATRICI Raw male fixed bracket for TRIMMERS Support fixe mâle pour ROGNEUSES Rohe männliche feste Halterung für REBSCHNEIDER		25
1A44051	Staffa fissa maschio grezza per PRO CUT Raw male fixed bracket for PRO CUT Support fixe mâle pour PRO CUT Rohe männliche feste Halterung für PRO CUT		70
1A32052	Staffa fissa maschio grezza per FRUIT Raw male fixed bracket for FRUIT Support fixe mâle pour FRUIT Rohe männliche feste Halterung für FRUIT		40
1A32050	Staffa fissa al trattore per CIMATRICI (fornire modello e tipo di trattore - vedi pag. 176-178) Bracket fixed to the tractor for TRIMMERS (type and version of tractor - see page 176-178) Support fixé au tracteur pour ROGNEUSES (indiquez le modèle et le type de tracteur - voir page 176-178) Am Traktor befestigte Halterung für REBSCHNEIDER (Modell und Typ des Traktors angeben - siehe seite 176-178)		45
1A44052	Staffa fissa al trattore per PRO CUT (fornire modello e tipo di trattore - vedi pag. 176-178) Bracket fixed to the tractor for PRO CUT (type and version of tractor - see page 176-178) Support fixé au tracteur pour PRO CUT (indiquez le modèle et le type de tracteur - voir page 176-178) Am Traktor befestigte Halterung für PRO CUT (Modell und Typ des Traktors angeben - siehe seite 176-178)		85
1A32053	Staffa fissa al trattore per FRUIT (fornire modello e tipo di trattore - vedi pag. 176-178) Bracket fixed to the tractor for FRUIT (type and version of tractor - see page 176-178) Support fixé au tracteur pour FRUIT (indiquez le modèle et le type de tracteur - voir page 176-178) Am Traktor befestigte Halterung für FRUIT (Modell und Typ des Traktors angeben - siehe seite 176-178)		55
1A32070	Attacco a tre punti con aggancio rapido per CIMATRICI Three-point hitch with quick coupling for TRIMMERS Attelage trois points avec attelage rapide pour ROGNEUSES Dreipunktaufhängung mit Schnellkupplung für REBSCHNEIDER		50
1A32090	Attacco a tre punti con aggancio rapido per PRO CUT Three-point hitch with quick coupling for PRO CUT Attelage trois points avec attelage rapide pour PRO CUT Dreipunktaufhängung mit Schnellkupplung für PRO CUT		110
1A32071	Attacco a tre punti con aggancio rapido per FRUIT Three-point hitch with quick coupling for FRUIT Attelage trois points avec attelage rapide pour FRUIT Dreipunktaufhängung mit Schnellkupplung für FRUIT		60
1A48000	Serbatoio idraulico 60 lt olio con pompa GR.2, radiatore per CIMATRICI BILAMA / COLTELLI / PRO CUT Hydraulic tank 60 lt oil with pump GR.2, radiator for TRIMMERS DOUBLE BLADE / KNIVES / PRO CUT Réservoir hydraulique huile 60 lt avec pompe GR.2, radiateur pour ROGNEUSES / DOUBLE LAME / COUTEAUX / PRO CUT Hydrauliktank 60 lt Öl mit Pumpe GR.2, Kühler für REBSCHNEIDER / DOPPELKLINGE / MESSERN / PRO CUT		180
1A48040	Serbatoio idraulico 60 lt olio con pompa GR.3, radiatore per INTERCEPPI / PFD / FRUIT / PRO CUT 1000 Hydraulic tank 60 lt oil with pump GR.2, radiator for INTER ROW / PFD / FRUIT / PRO CUT 1000 Réservoir hydraulique huile 60 lt avec pompe GR.2, radiateur pour INTERCEPS / PFD / FRUIT / PRO CUT 1000 Hydrauliktank 60 lt Öl mit Pumpe GR.2, Kühler für STOCKKRÄUMER / PFD / FRUIT / PRO CUT 1000		190
1A0090004	Albero cardano categoria 6 - L = 90 cm P.T.O. drive shaft category 6 - L = 90 cm Arbre à cardan catégorie 6 - L = 90 cm Kardanwelle der Kategorie 6 - L = 90 cm		
1A32001	4 ruote cavalletto per CIMATRICI 4 wheels stand for TRIMMERS 4 roues support pour ROGNEUSES 4 Räder stehen für REBSCHNEIDER		10
1A32003	4 ruote cavalletto per PFD/FRUIT/PRO CUT 4 wheels stand for PFD/FRUIT/PRO CUT 4 roues support pour PFD/FRUIT/PRO CUT 4 Räder stehen für PFD/FRUIT/PRO CUT		10